

**2021
NEW**

HOLTOP

HOLTOP Comfort Fresh Air

Heat Recovery Ventilator

CFA 250T / 350T / 500T

SPECIFICATIONS

MODEL No.	CFA 250T	CFA 350T	CFA 500T
Voltage [V] / Frequency [Hz]	230V/50Hz		
Airflow [m ³ /h]	250	350	500
External Static Pressure [Pa]	130	150	160
Temperature Efficiency at Rated Airflow [%]	85	85	85
Max Temperature Efficiency [%]	95	95	95
Rated Power [W]	170	320	480
Noise [dB(A)] ^①	35	37	39
Energy Efficiency Class	A	A	A
Weight [kg]	40	40	50

^①Note: This noise level is measured under the condition of 70% of the maximum air volume and 50Pa static pressure.

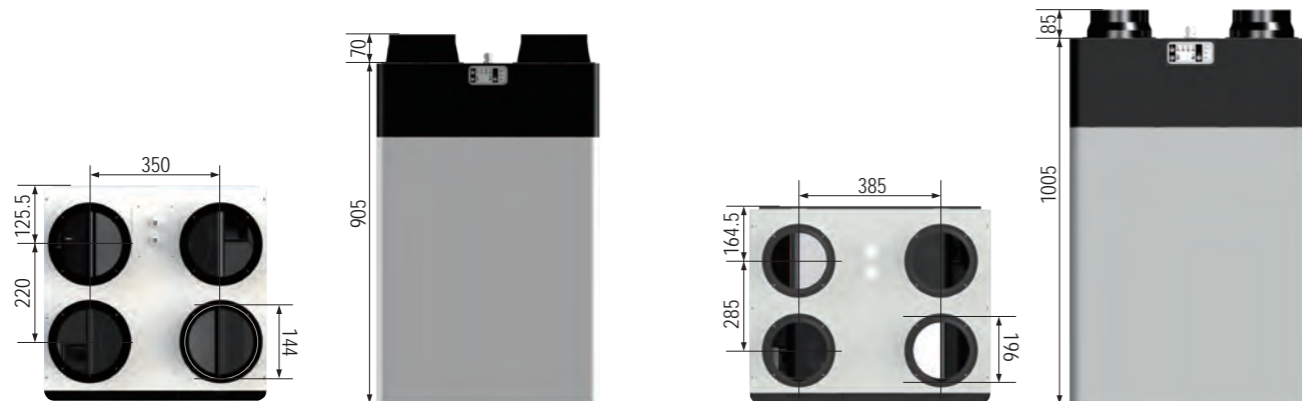

CFA 250T ~ CFA 350T Dimensions

CFA 500T Dimensions

Beijing Holtop Air Conditioning Co.,Ltd

No. 5 Yard, 7th Guanggu Street, Badaling Economic Development Zone,
Yanqing District, Beijing, China

Telephone: +400-628-2002

Website: www.holtop.com.cn

E-mail: export@holtop.com.cn



360°FACTORY TOUR



FACEBOOK



COMFORT AIR

HOLTOP Comfort Fresh air HRV brings outdoor fresh air and create a healthy living environment with oxygen, suitable temperature and humidity, and almost zero pollutants through air exchange.

CLEAN AIR

High-efficiency air purification. Filtration class is G4 / F7 (optional), effectively prevent outdoor dust, pollen, and other particles to make air fresh and clean.

EXTREME SILENCE

The lowest operating noise is 31dB(A).

EXCELLENT ENERGY SAVING

It is equipped with double high-efficiency EC fans and a high-efficiency counterflow heat exchangers (efficiency up to 95%).



EPP STRUCTURE

The internal structure is made by EPP material, which is light weight, heat preserve, silent, environmental friendly, no odor, etc. It has the good performance for air tightness and thermal insulation.

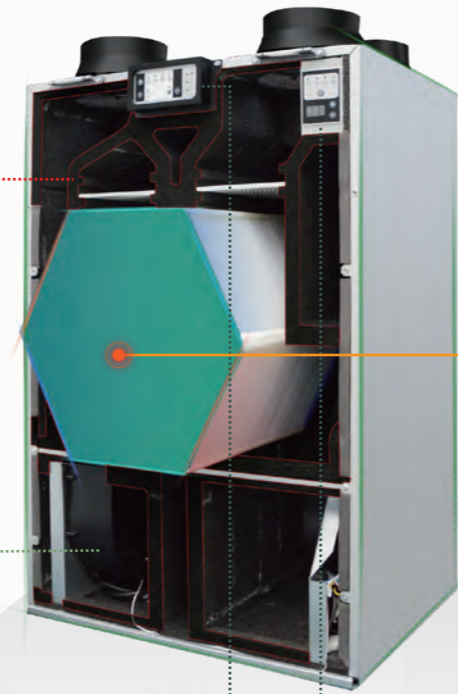
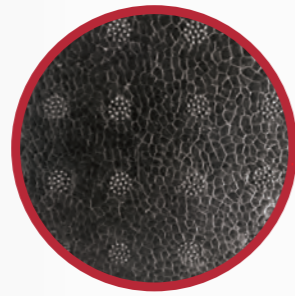

CONSTANT AIRFLOW EC FANS

It is equipped with constant airflow EC fans. The EC fans can regulate the airflow to the set airflow automatically regardless different pipe length, filter block or any other pressure drop situations.

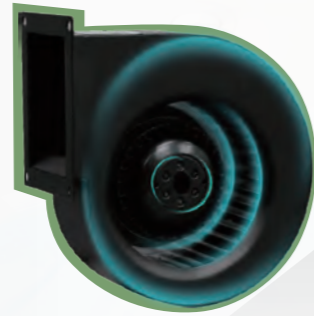

VARIOUS CONTROL FUNCTIONS

It is composed of a main control, a commissioning control, and a remote LCD control panel (optional), which can realize the functions of real time display, one-key operation, fault alarm, remote control and centralized control.



Constant airflow function



Airflow balance rate setting



Automatic By-pass function



Defrost function



Humidity control function



Other functions

HUMANIZED DESIGN

- Flexible installation:**
 Left type or right type is optional. The installation type can be adjusted at site to meet different installation requirements.
- Easy operation**
 The airflow can be set by user according to the demand.
- One-key fan boost function**
 The unit provides fan boost function, it can be operated with one-key. After pressing the button, the unit will run at maximum airflow for 60 minutes (running time is adjustable), then return to the original status.

HIGH-EFFICIENCY HEAT EXCHANGE MATERIAL

- ✓ Upmost thermal performance
- ✓ Great air tightness with good rigidity
- ✓ Oxidation/Mildew resistance

ULTRA-HIGH HEAT EXCHANGE EFFICIENCY

The air flows counterflowly to extend the heat exchange time and make heat transfer more thoroughly. The heat recovery efficiency is up to 95%.

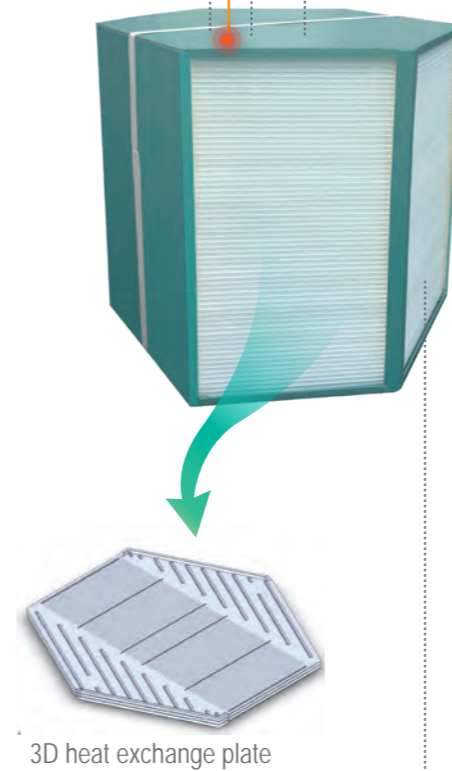
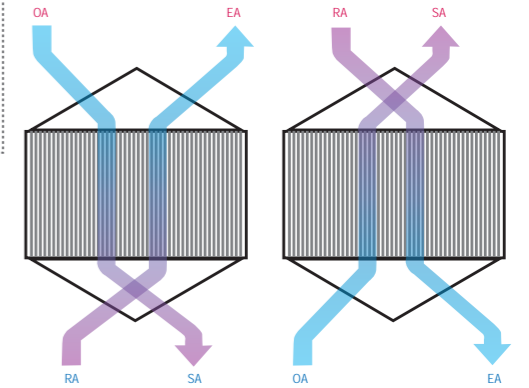

3D HEAT EXCHANGE CHANNEL

In the air channels, the heat can be transferred from 3 directions. Large heat exchange surface allows the unit to achieve higher level of efficiency.

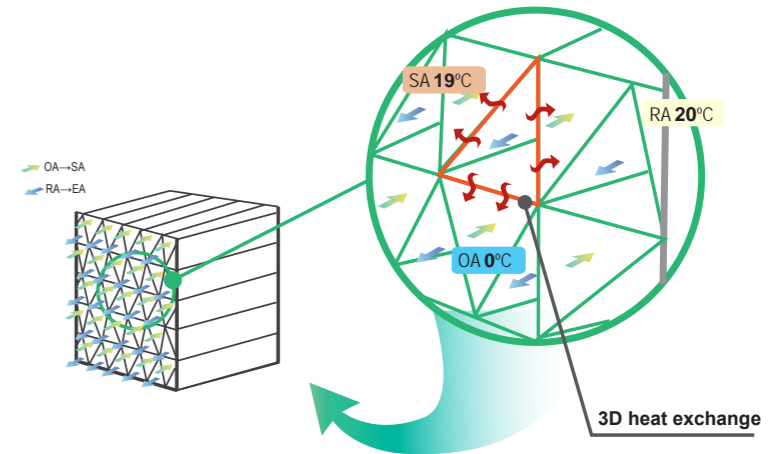

WASHABLE CORE, EASY TO CLEAN

The core of heat exchanger is washable, and the service life is up to 15 years.

